

G.F. - Q.

Profili Quadri
Square Frames

LeanProducts srl
Via Bassanti, 8 | 33170 Pordenone (PN)
T +39 0434 572757 - F +39 0434 572750
info@LeanProducts.eu - www.LeanProducts.eu

V 40

SEZIONE - SECTION

E

LEAN GREEN FACTORY CATALOGUE

Index



E-3

Profili

Frames



E-4

Angolari completi e Snodi

Angle brackets and joints

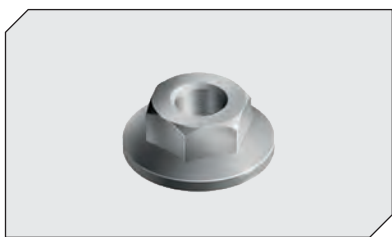

E-6

Viteria

Screws

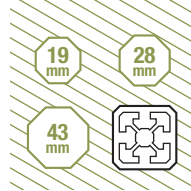

Profili

Frames

Profilo 30 x 30

Profile 30 x 30

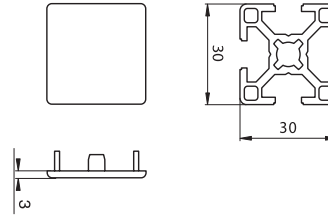
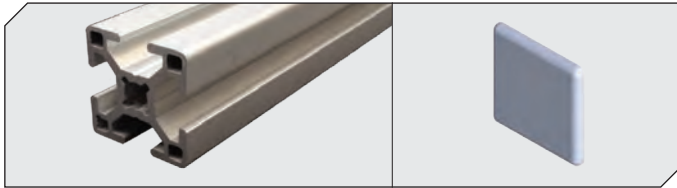

NOME	Profilo 30 x 30	L= 5600 mm	Cappuccio di copertura 30 x 30
NAME	Profile 30 x 30		Cap 30 x 30
CODE	LPQ-3030		LPQ-3030CAPG

TECHNICAL DATA
 ■ Material: Aluminium
 ■ Mass Unit: 0.9 Kg / m

Profilo 45 x 45

Profile 45 x 45

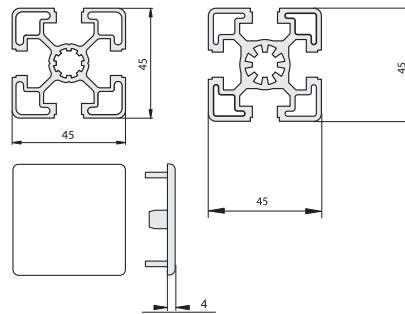

NOME	Profilo 45 x 45	Profilo pesante 45 x 45	L=6070 mm	Cappuccio di copertura 45 x 45
NAME	Profile 45 x 45	Heavy Profile 45 x 45		Cap 45 x 45
CODE	LPQ-4545	LPQ-4545P		LPQ-4545CAPG

TECHNICAL DATA
 ■ Material: Aluminium
 ■ Mass Unit: LPQ-4545 1.6 Kg / m
 LPQ-4545P 2 Kg / m

Profilo 45 x 90

Profile 45 x 90

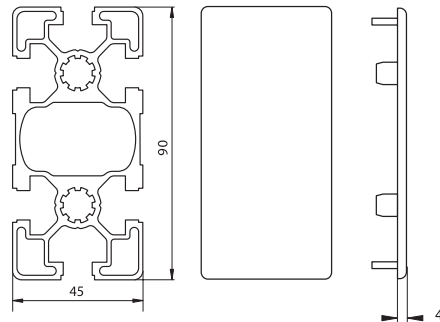
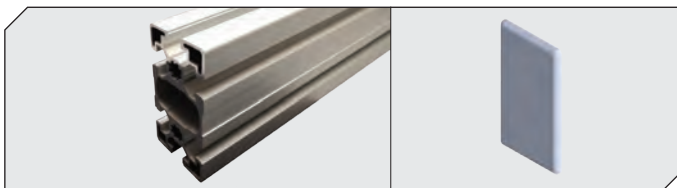

NOME	Profilo 45 x 90	L= 6070 mm	Cappuccio di copertura 45 x 90
NAME	Profile 45 x 90		Cap 45 x 90
CODE	LPQ-4590		LPQ-4590CAPG

TECHNICAL DATA
 ■ Material: Aluminium
 ■ Mass Unit: 4.2 Kg / m

Copri Cava

Frame Guard

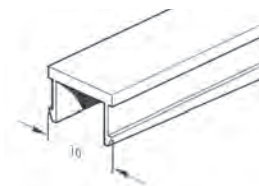
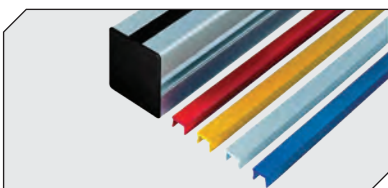

COLORE	Nero	Rosso	Giallo	Grigio	Blu	
COLOR	Black	Red	Yellow	Grey	Blue	
L= 2000 mm						
CODE	C8	LPQ-CC8N	LPQ-CC8R	LPQ-CC8Y	LPQ-CC8G	LPQ-CC8BL
	C10	LPQ-CC10N	LPQ-CC10R	LPQ-CC10Y	LPQ-CC10G	LPQ-CC10BL

Angolari completi e snodi

Angle brackets and joints

LEAN GREEN FACTORY CATALOGUE

E

SEZIONE - SECTION

V 4.0

LEANPRODUCTS®
Lean manufacturing

Angolare 30 x 30

Bracket 30 x 30

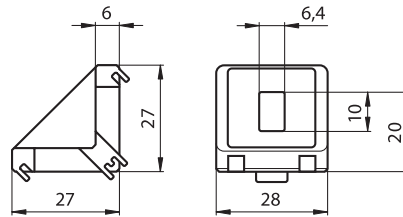

NOME	Angolare 30 x 30	Cuffia 30 x 30
NAME	Bracket 30 x 30	Cover cap 30 x 30
CODE	LPQ-ANG3030	LPQ-CUF3030



TECHNICAL DATA

- Material: Aluminium Diecast
- Weight: 20 g

Angolare 30 x 60

Angular connector 30 x 60

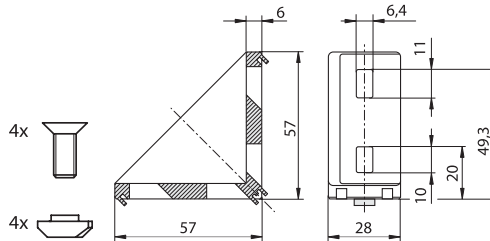

NOME	Angolare 30 x 60	Cuffia 30 x 60
NAME	Bracket 30 x 60	Cover cap 30 x 60
CODE	LPQ-ANG3060	LPQ-CUF3060



TECHNICAL DATA

- Material: Aluminium Diecast
- Weight: 58 g

Angolare 45 x 45

Bracket 45 x 45

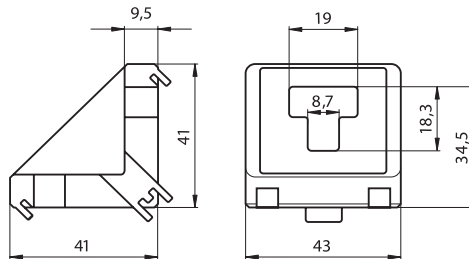

NOME	Angolare 45 x 45	Cuffia 45 x 45
NAME	Bracket 45 x 45	Cover cap 45 x 45
CODE	LPQ-ANG4545	LPQ-CUF4545



TECHNICAL DATA

- Material: Aluminium Diecast
- Weight: 56 g

Angolare 45 x 90

Bracket 45 x 90

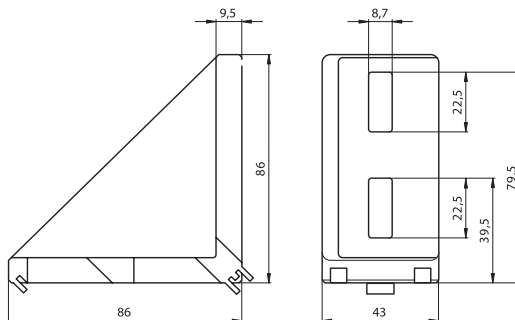
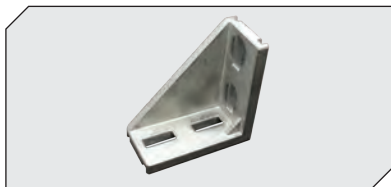

NOME	Angolare 45 x 90	Cuffia 45 x 90
NAME	Bracket 45 x 90	Cover cap 45 x 90
CODE	LPQ-ANG4590	LPQ-CUF4590



TECHNICAL DATA

- Material: Aluminium Diecast
- Weight: 162 g

19
mm28
mm43
mm

Angolare 45° 30 x 30

Bracket 45° 30 x 30



NOME	Angolare 45° 30 x 30
NAME	Bracket 45° 30 x 30
CODE	LPQ-ANG45

COMPATIBLE SCREW AND NUT ▶ E-6 / 7

	Vite Screw	Dado Nut
C8	LP-V014	LP-DM004
C10	LP-V013	LP-DM008
Centrale Head	LP-V015	

Snodo 30 x 30

Joint 30 x 30



NOME	Snodo 30 x 30
NAME	Joint 30 x 30
CODE	LPQ-SNO3030

COMPATIBLE SCREW AND NUT ▶ E-6 / 7

	Vite Screw	Dado Nut
C8	LP-V014	LP-DM004
C10	LP-V011	LP-DM008
Centrale Head	LP-V012	

Snodo 45 x 45

Joint 45 x 45



NOME	Snodo 45 x 45
NAME	Joint 45 x 45
CODE	LPQ-SNO4545

COMPATIBLE SCREW AND NUT ▶ E-6 / 7

	Vite Screw	Dado Nut
C10	LP-V013	LP-DM008
Centrale Head	LP-V015	

Snodo 45 x 45 per bracci

Joint arm 45 x 45



NOME	Snodo 45 x 45 per bracci
NAME	Joint arm 45 x 45
CODE	LPQ-4545B

COMPATIBLE SCREW AND NUT ▶ E-6 / 7

	Vite Screw	Dado Nut
C10	LP-V011	LP-DM008
Centrale Head	LP-V009	

Snodo 45 x 90 per bracci

Joint arm 45 x 90



NOME	Snodo 45 x 90 per bracci
NAME	Joint arm 45 x 90
CODE	LPQ-4590B

COMPATIBLE SCREW AND NUT ▶ E-6 / 7

	Vite Screw	Dado Nut
C10	LP-V011	LP-DM008
Centrale Head	LP-V009	

Viteria

Screws

Vite testa a martello

Hammer head screw

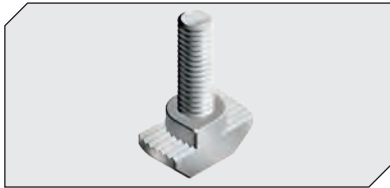

NOME	Vite testa a martello					100 pezzi
NAME	Hammer head screw					100 pieces
CODE	M	C	b	l	L	
LP-VM001	M6	C8	10	14	16	
LP-VM002	M6	C8	14	18	20	
LP-VM003	M6	C8	18	23	25	
LP-VM004	M8	C10	14	14	20	
LP-VM005	M8	C10	19	19	25	
LP-VM006	M8	C10	24	24	30	

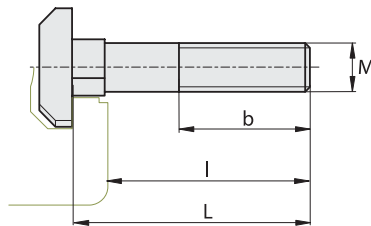

Inserto testa a martello

Hammer head insert

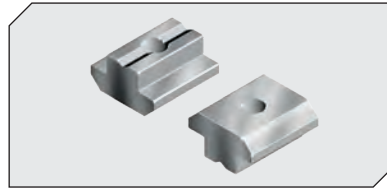

NOME	Inserto testa a martello		100 pezzi
NAME	Hammer head insert		100 pieces
CODE	M	C	
LP-IM001	M6	C8	
LP-IM002	M6	C10	
LP-IM003	M8	C10	

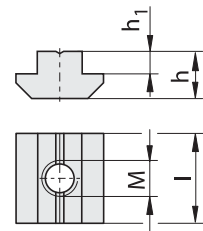

Dado con testa a martello

Hammer head nut

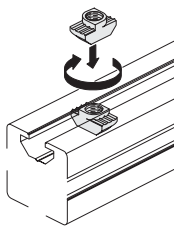
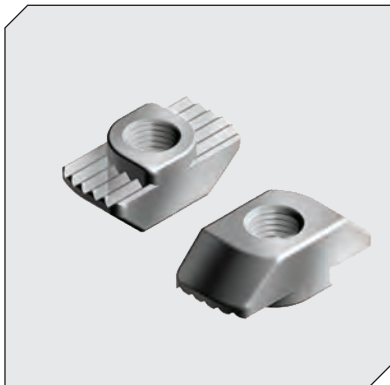

NOME	Dado con testa a martello		100 pezzi
NAME	Hammer head nut		100 pieces
CODE	M	C	
LP-DM001	M4	C6	
LP-DM002	M4	C8	
LP-DM003	M5	C8	
LP-DM004	M6	C8	
LP-DM005	M4	C10	
LP-DM006	M5	C10	
LP-DM007	M6	C10	
LP-DM008	M8	C10	

Dado a colletto

Collar Nut

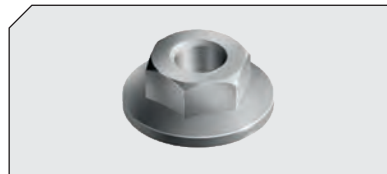

NOME	Dado a colletto		100 pezzi
NAME	Collar nut		100 pieces
CODE	M		
LP-D001	M6		
LP-D002	M8		

Dado autobloccante

Self locking bolt



NOME	Dado autobloccante		100 pezzi
NAME	Self locking bolt		100 pieces
CODE	M		
LP-D003	M6		
LP-D004	M8		

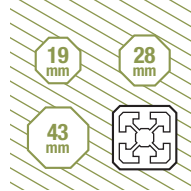

Vite flangiata

Screw with flange



NOME	Vite flangiata		100 pezzi
NAME	Screw with flange		100 pieces
CODE	M	L mm	
LP-V001	M6	14	
LP-V002	M6	16	
LP-V003	M8	14	
LP-V004	M8	16	

Vite

Screw



NOME	Vite		100 pezzi
NAME	Screw		100 pieces
CODE	M	L mm	
LP-V005	M6	14	
LP-V006	M6	16	
LP-V007	M8	14	
LP-V008	M8	16	
LP-V016	M8	60	

Grano M3

M3 grub screw



NOME	Grano M3
NAME	M3 grub screw
CODE	LP-G001

CODE	NOME	NAME
LP-V009	Vite M12 L= 30 mm	Screw M12 L= 30 mm
LP-V010	Vite Trilobata M5 x 8 mm	Screw M5 x 8 mm
LP-V011	Vite Tceir M8 x 14 mm	Screw Tceir M8 x 14 mm
LP-V012	Vite Tcei M8 x 30 mm	Screw Tcei M8 x 30 mm
LP-V013	Vite M8 x 16 mm	Screw M8 x 16 mm
LP-V014	Vite M6 x 12 mm	Screw M6 x 12 mm
LP-V015	Vite Autofilettante S12 x 30-T50	Screw Self-Locking S12 x 30-T50

19
mm

28
mm

43
mm

